

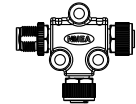



THIS DOCUMENT IS SUBJECT TO CHANGE WITHOUT NOTICE. IT IS CONFIDENTIAL AND A PROPERTY OF Amphenol LTW. DISCLOSURE TO THIRD PARTY HAS TO BE AUTHORIZED BY Amphenol LTW.

REV.	ECN NO.	DATE	SIGN	DESCRIPTION
C	CI80317	2018-12-12	Frank Deng	Change Coiling Size

Pro	① HPC-050505-FMF-TS001	3 Tee Adaptor 2Pcs	
	② HMCP-05BFFT-SL8001 $\triangle B$	Female Terminator 1Pcs	
	③ HMCP-05BMMT-SL8001 $\triangle B$	Male Terminator 1Pcs	
	④ P-555500-FFFM00-S001	4Tee Adaptor 2Pcs	
	⑧ P-555555-FFFFFM-S001	6Tee Adaptor 2Pcs	
	⑤ HPC-000505-OMF-CSA02	2 Ends With Cable 2M, 1Pcs	
	⑥ HPC-000505-OMF-CSA05	2 Ends With Cable 5M, 1Pcs	
⑦ HPC-000505-OMF-CSA10	2 Ends With Cable 10M, 1Pcs		

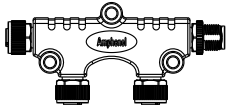
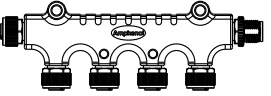
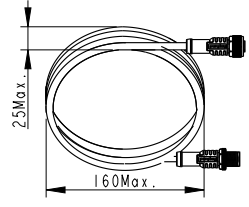
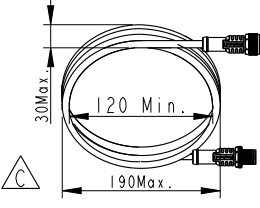
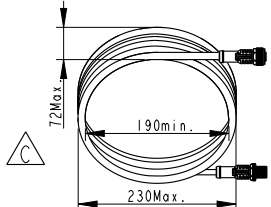
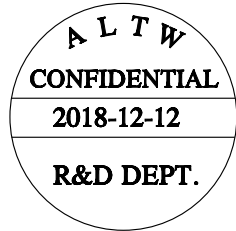

Note:
 * 3 Tee adaptor: 2PCS
 * Female Terminator 1PCS
 * Male Terminator :1PCS
 * 4Tee adapter connector 2pcs
 * 6 Tee adapter connector 2pcs
 * 2 Ends Cable, cable length 2m,5m,10m各1PCS,
 * All connector put into the blister tray
 * 注意繞線尺寸需符合圖面要求, 否則會影響產品裝入彩盒。
 * 5pcs blister tray /Carton
 * Net weight: 7.1kg / Carton
 * Gross weight: 9.3Kg / Carton

UNIT:mm		
TOLERANCE		

TITLE NMEA2000 Starter Kit Plastic, Pro Type		
SCALE Free	SIZE A4	SHEET 1 OF 2
REV. C	WC-REV. A.1	QC: Inspection item

Amphenol LTW
 安費諾亮泰企業股份有限公司

ITEM NO HPC-P-001	DRAWN BY Frank Deng	DATE 2018-12-12
DWG NO HPC-P-001	CHECKED BY Fisher Wang	DATE 2018-12-12
CUSTOMER ALTW	APPROVED BY Kevin Hu	DATE 2018-12-12

THIS DOCUMENT IS SUBJECT TO CHANGE WITHOUT NOTICE. IT IS CONFIDENTIAL AND A PROPERTY OF Amphenol LTW. DISCLOSURE TO THIRD PARTY HAS TO BE AUTHORIZED BY Amphenol LTW.

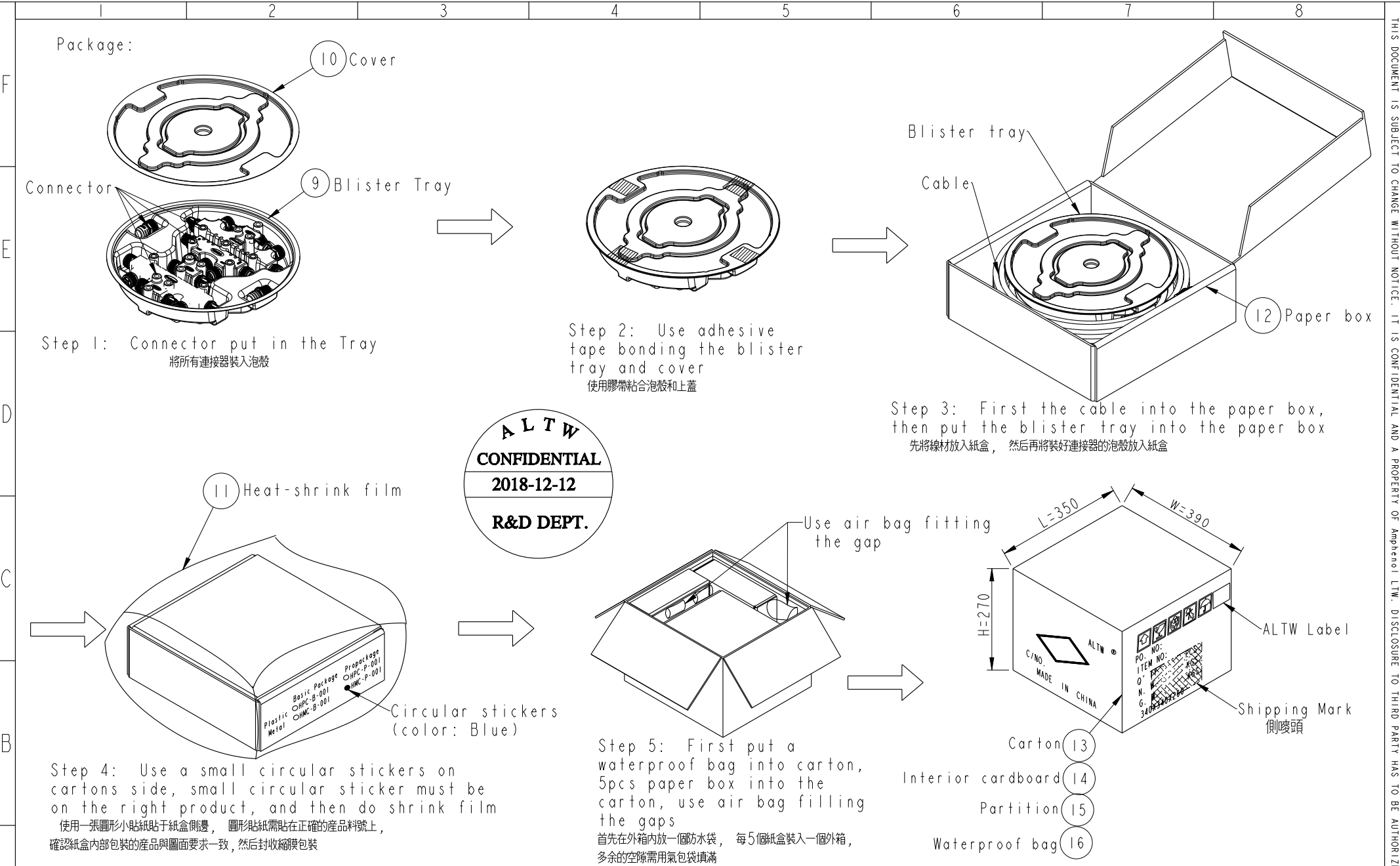

UNIT: mm		TITLE		<h1>Amphenol LTW</h1> 安費諾亮泰企業股份有限公司	ITEM NO	DRAWN BY	DATE
		NMEA2000 Starter Kit Plastic, Pro Type			HPC-P-001	Frank Deng	2018-12-12
		TOLERANCE			DWG NO	CHECKED BY	DATE
		SCALE	SIZE	SHEET	OF		
		Free	A4	2	2		
		REV.	WC-REV.	Inspection item		APPROVED BY	DATE
		C	A.1			Kevin Hu	2018-12-12
					CUSTOMER		
					ALTW		
FMW10702-01-02A1							