

REV.	ECN NO.	DATE	SIGN	DESCRIPTION
B	CI80527	2018/12/22	Mafei	Update The Note.
C	CI90951	2019/06/12	NianPing Yu	Modify salt spray specifications

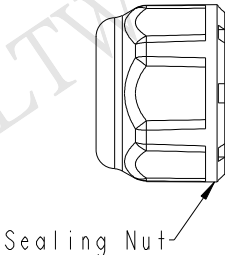

Sealing Nut

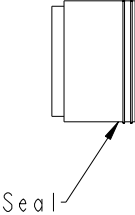

Seal

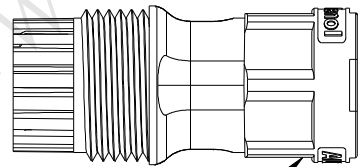

Clamp Ring

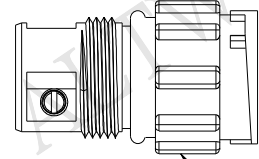

Connector

Material Specification:

- * Connector: Thermoplastic
- * Terminal: Copper Alloy, Silver Plated.
- * Seal & O-Ring: Rubber.
- * UL Rated: UL 94V-0, fl.
- * RoHS Compliant.

Electrical Specification:

- * Contact Resistance: 10mΩ Max.
- * Insulation Resistance: 100MΩ Min.
- * Dielectric Withstand Voltage: 1,600 Vac.

Mechanical Specification:

- * Durability: 1000 Cycles.
- * Wire conductor: 14AWG~12AWG(2.0mm²~3.3mm²).
- * Wire insulation OD: Max 4.0mm.
- * Torque Force for Clamp Ring: 6~8 kgf-cm
- * Torque Force for Seal Nut: 8~15 kgf-cm
- * Torque Force for Screw: 4~5 kgf-cm

Environmental Specification:

- * Waterproof Rating: IP67
- * Temperature Range: -40°C to 105°C.
- * Salt Spray: Mated, 1000 Hours.
- * Safety Compliance: UL 1977.

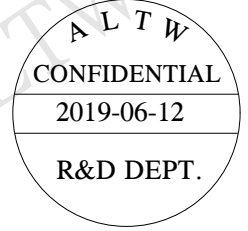
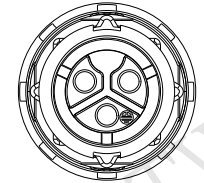
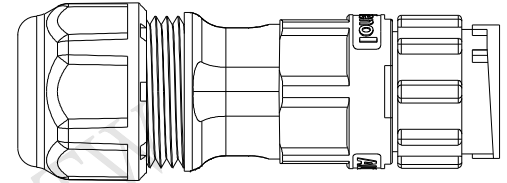
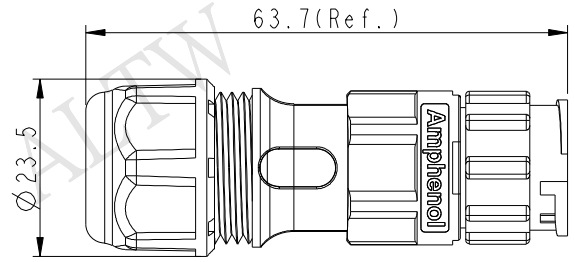

UNIT:mm		
TOLERANCE	±0.5 mm	

TITLE POWER Field Installable Cable Screw-in Type M Conn F Pin			
SCALE 1:1	SIZE A4	SHEET 1 OF 2	
REV. C	WC-REV. A.3	QC: Inspection item	

Amphenol LTW
安費諾亮泰企業股份有限公司

ITEM NO	DRAWN BY NianPing Yu	DATE 2019-06-12
DWG NO PWC-XXBMFB-LL7XPP	CHECKED BY Fisher Wang	DATE 2019-06-12
CUSTOMER ALTW	APPROVED BY Max Yang	DATE 2019-06-12

THIS DOCUMENT IS SUBJECT TO CHANGE WITHOUT NOTICE. IT IS CONFIDENTIAL AND A PROPERTY OF Amphenol LTW. DISCLOSURE TO THIRD PARTY HAS TO BE AUTHORIZED BY Amphenol LTW.

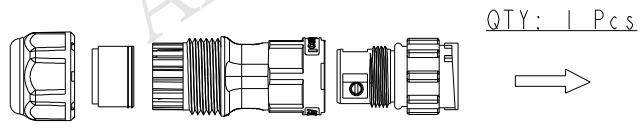

QTY: 1 Pcs

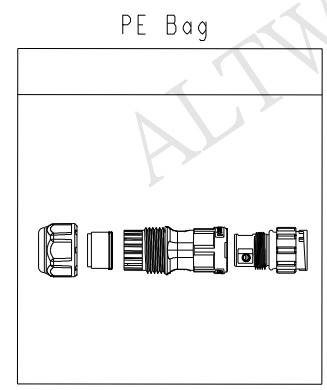

QTY: XX Pcs

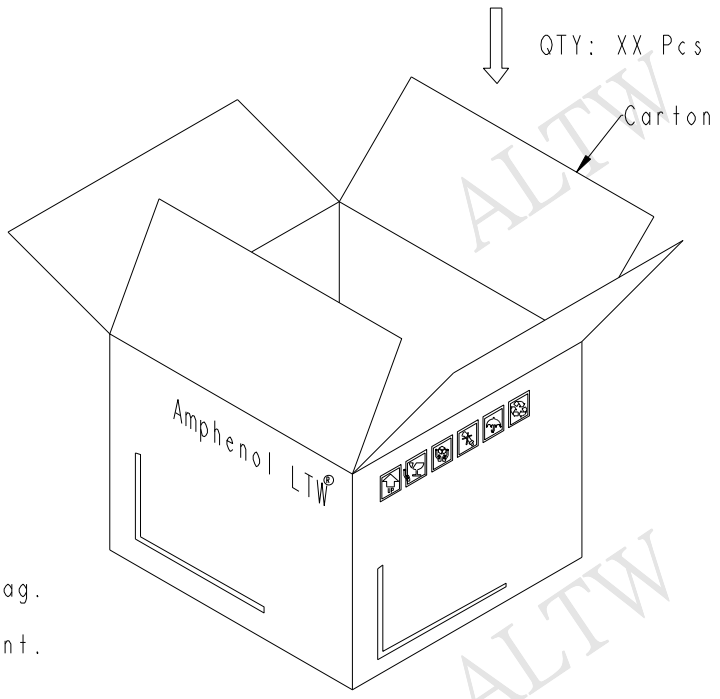

Ordering Information:

PWC-XXBMFB-LL7XPP

Number of Contacts
02
03

S: With Red Color Seal 1, Cable OD 6.0~8.0mm.
M: With Yellow Color Seal 2, Cable OD 8.0~10.0mm.
L: With Blue Color Seal 3, Cable OD 10.0~12.0mm.
A: With Seal 1 & Seal 2 & Seal 3.

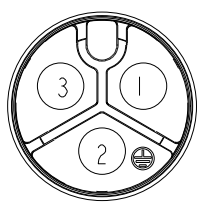

20A ; 300Vac/Vdc
3 Contacts(03)

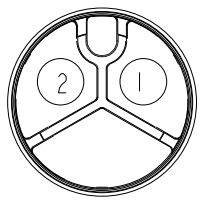

20A ; 300Vac/Vdc
2 Contacts(02)

- Note:
- * One Set Unassembled In One PE Bag.
(每一組未組裝，放置於一個PE袋，並封口，如圖示)
 - * Label is Attached To PE Bag Front.
(標籤貼在PE袋正面)

UNIT:mm		
TOLERANCE ±0.5 mm		

TITLE POWER Field Installable Cable Screw-in Type M Conn F Pin			
SCALE 1:1	SIZE A4	SHEET 2 OF 2	
REV. C	WC-REV. A.3	QC: Inspection item	

Amphenol LTW
安費諾亮泰企業股份有限公司

ITEM NO	DRAWN BY NianPing Yu	DATE 2019-06-12
DWG NO PWC-XXBMFB-LL7XPP	CHECKED BY Fisher Wang	DATE 2019-06-12
CUSTOMER ALTW	APPROVED BY Max Yang	DATE 2019-06-12