

5	6	7	8
REV.	ECN NO.	DATE	SIGN



- ① F Housing
- ② O-Ring*2
- ③ O-Ring
- ④ Nut
- ⑤ Ins_Housing

- ⑥ Pin Ass'y
- ⑦ PE Bag (HPE00910085)

- ⑧ Body

- ⑨ Seal(12MM)

- ⑩ Clamp Ring (12MM)

- ⑪ Clamp Nut (12MM)

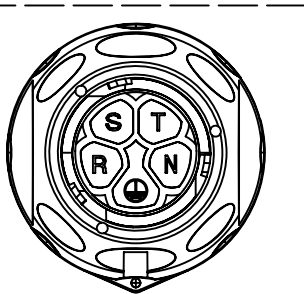
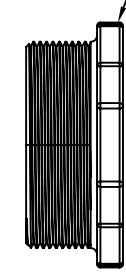
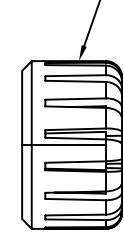
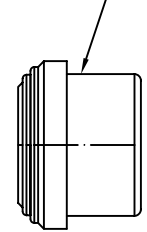
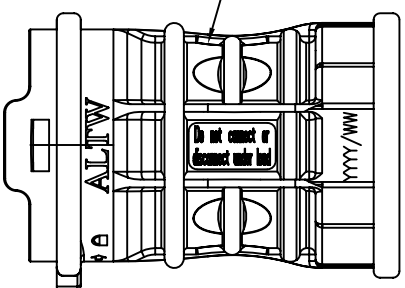
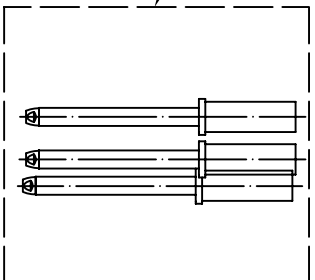
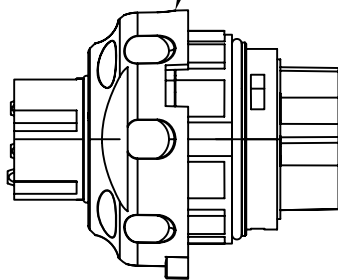

Pin Assignments
Front View

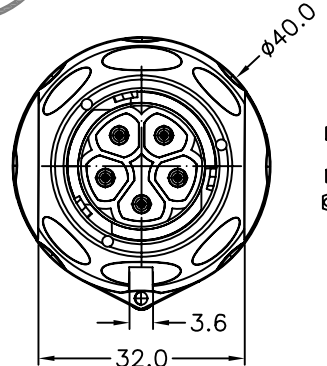

Conn.

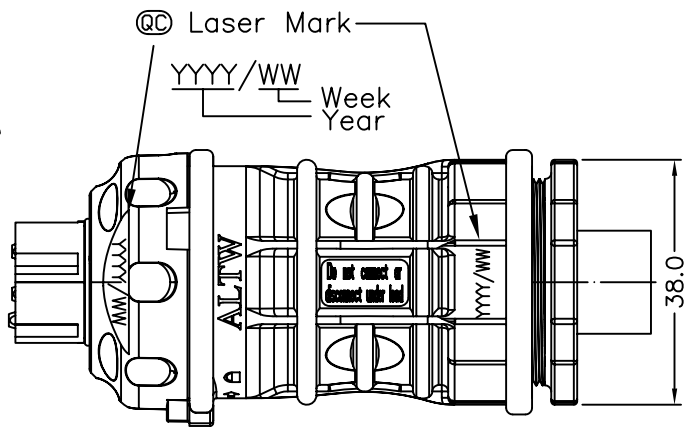

Note:

- * @C Important Dimensions To Check.(重點檢查尺寸)
- * Voltage (電壓) : AC 660V ; DC 1000V
- * Current (電流) : 25A
- * Please refer to manual for Ass'y instruction (使用方式請參閱組裝說明書)
- * Standard (認證) :ULXXXXX ;CSAXXXX; TUVXXXXX
- * Waterproof Rate(防水等級) : IP68_3M6H(Mating對接)
- * Female Housing(母膠芯): m-PPE(F1),Black (黑)
- * Male Pin(公端子): Copper(銅),Tin Plated(鍍錫)
- * O-ring (O型環): Silicone (矽樹脂),Gray (灰)
- * Cable OD range(線材範圍) : 12mm~9mm
- * Wire Size(導體尺寸): 12AWG
- * Flame Class(防火等級): UL94V-0
- ⑬ * One Set Unassembled in one PE Bag.
- ⑫⑬ * One Set Ass'y Instructions & Tool in one PE Bag. (每包袋子中含有未組裝零件, 組裝說明書及工具)

UNIT:mm	
TOLERANCE	
.X	±0.25
.XX	±0.1
.XXX	±0.05
ANGLES	±1°

TITLE		PV Power Conn 5Pin Cable(12MM) Female Conn Male Pin	
SCALE	Free	SHEET	1 OF 1
REV.	A	SIZE	A4
		QC :Inspection Item	

Amphenol LTW
安費諾亮泰企業股份有限公司

ITEM NO	LTWPWH-05BFMC-LL8002
DWG NO	LTWPWH-05BFMC-LL8002
CUSTOMER	

DRAWN BY	Micky	DATE	2011/06/13
CHECKED BY	Kevin	DATE	2011/06/13
APPROVED BY	Victor	DATE	2011/06/13

THIS DOCUMENT IS SUBJECT TO CHANGE WITHOUT NOTICE. IT IS CONFIDENTIAL AND A PROPERTY OF Amphenol LTW. DISCLOSE TO THIRD PARTY HAS TO BE AUTHORIZED BY Amphenol LTW.

F
E
D
C
B
A

1 2 3 4 5 6 7 8