

THIS DOCUMENT IS SUBJECT TO CHANGE WITHOUT NOTICE. IT IS CONFIDENTIAL AND A PROPERTY OF Amphenol LTW. DISCLOSURE TO THIRD PARTY HAS TO BE AUTHORIZED BY Amphenol LTW.

REV.	ECN NO.	DATE	SIGN	DESCRIPTION
B	LEN1580328~31	2015/08/19	Lu Di	Change To Common Drawing
C	LEN1690197~200	2016/09/23	Mafei	Change The Wire Color.

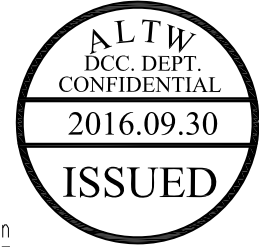
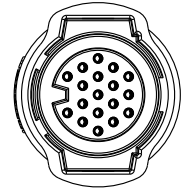
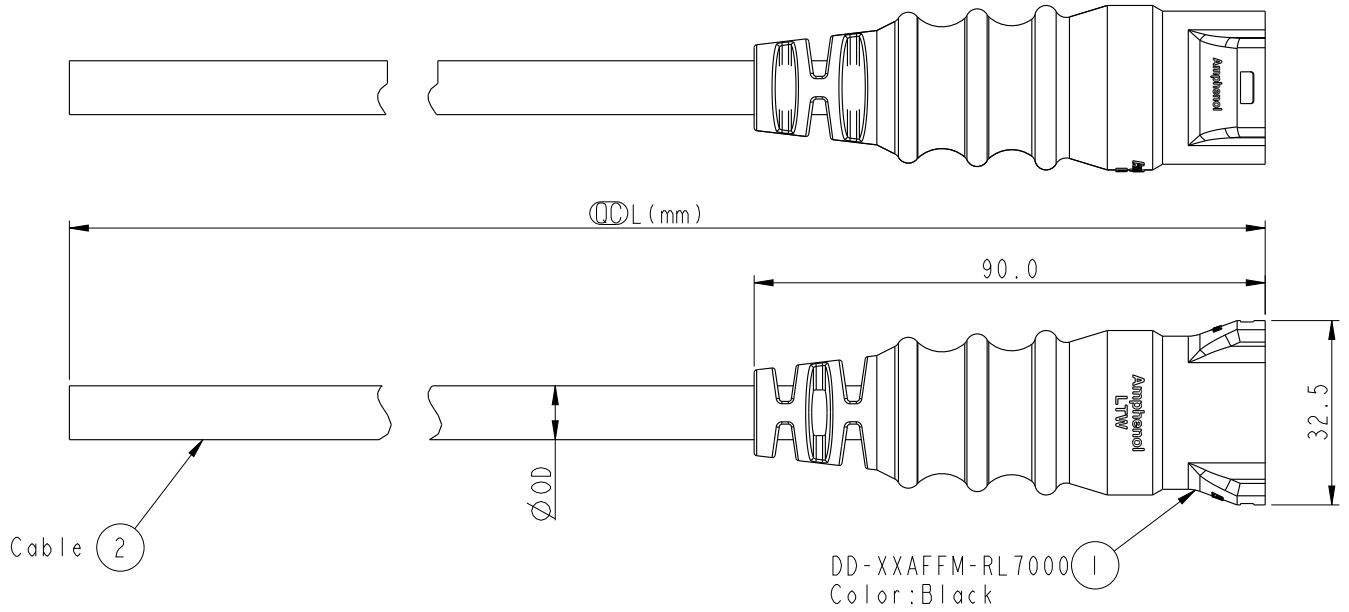
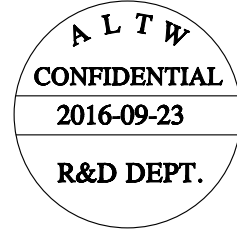

DD-XXAFFM-RL7000 1
Color:Black

DD-XXAFFM-RL7A XX

Large Size Current Rating 5A

XX:No. Of Pin(Pin 數)

A:Cable With S/R(線端帶網尾)

F:Female Connector(母座)

F:Female Pin(母Pin)

M:Molding Type(射出成型)

XX:01~99Meter
01:01Meter
02:02Meter
:
:
99:99Meter

A:UL 2464 Cable
7:IP67(防水等級 67)
L:Straight(180°)
R:Snap In With Latch(彈臂卡合)

Note:

- * \varnothing Important Dimension
- * Waterproof Rate: IP67
- * Housing: M-PPE, Black
- * Female Pin: Copper Alloy, Gold Plated
- * Cable: UL2464 20#,PVC Jacket, Black.
- * Cable Length Tolerance: 01M:±40mm
02M~05M:±60mm
06M~10M:±100mm
11M~30M:±200mm
31M~99M:±500mm
- * Prohibiting the use of place in oils



DD-10AFFM-RL7AXX	∅ 9.0
DD-12AFFM-RL7AXX	
DD-14AFFM-RL7AXX	∅ 9.5
DD-18AFFM-RL7AXX	
Part No.	Cable OD

UNIT:mm		TITLE	LARGE CABLE RBL F CONN F PIN		
TOLERANCE		SCALE	SIZE	SHEET	OF
±0.5mm		3:4	A4	1	2
REV.	WC-REV.	∅: Inspection item			
C	A.7				

Amphenol LTW
安費諾亮泰企業股份有限公司

ITEM NO	DRAWN BY	DATE
	Mafei	2016-09-23
DWG NO	CHECKED BY	DATE
DD-XXAFFM-RL7AXX	Youdan	2016-09-23
CUSTOMER	APPROVED BY	DATE
ALTW	Jerry	2016-09-23

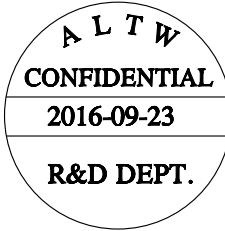
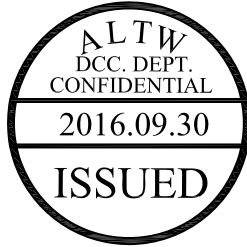
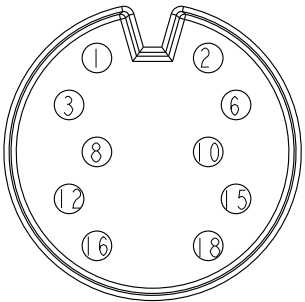
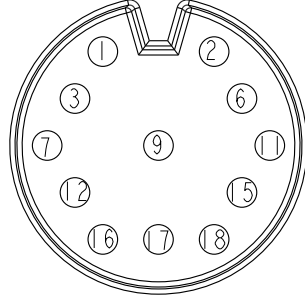
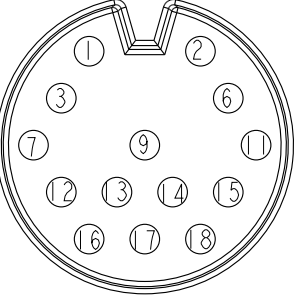
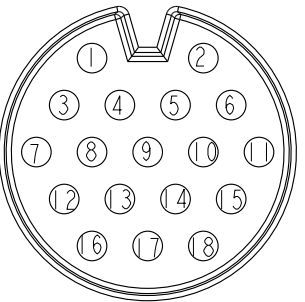
THIS DOCUMENT IS SUBJECT TO CHANGE WITHOUT NOTICE. IT IS CONFIDENTIAL AND A PROPERTY OF AMPHENOL LTW. DISCLOSURE TO THIRD PARTY HAS TO BE AUTHORIZED BY AMPHENOL LTW.

△B									
△C									
Pin Out	18 Purple(紫) 17 -- 16 Brown(棕) 15 Orange(橘) 14 -- 13 -- 12 Yellow(黃) 11 -- 10 Gray(灰) 9 -- 8 Red(紅) 7 -- 6 Green(綠) 5 -- 4 -- 3 Blue(藍) 2 White(白) 1 Black(黑)	18 Black/White(黑/白) 17 Orange(橘) 16 Pink(粉紅) 15 Gray(灰) 14 -- 13 -- 12 Purple(紫) 11 Yellow(黃) 10 -- 9 Green(綠) 8 -- 7 White(白) 6 Brown(棕) 5 -- 4 -- 3 Blue(藍) 2 Black(黑) 1 Red(紅)	18 Black/White(黑/白) 17 Brown/White(棕/白) 16 Light Green(淺綠) 15 Pink(粉紅) 14 Purple(紫) 13 Brown(棕) 12 Orange(橘) 11 Yellow(黃) 10 -- 9 Gray(灰) 8 -- 7 Red(紅) 6 Green(綠) 5 -- 4 -- 3 Blue(藍) 2 White(白) 1 Black(黑)	18 Light Green(淺綠) 17 Green/White(綠/白) 16 Orange/White(橘/白) 15 Brown/White(棕/白) 14 Blue/White(藍/白) 13 Black/White(黑/白) 12 Red/White(紅/白) 11 Orange(橘) 10 Pink(粉紅) 9 Gray(灰) 8 Purple(紫) 7 Yellow(黃) 6 Green(綠) 5 White(白) 4 Brown(棕) 3 Blue(藍) 2 Black(黑) 1 Red(紅)					
Pin Assignments Front View	 10Pin	 12Pin	 14Pin	 18Pin					
UNIT:mm	TOLERANCE ±0.5		TITLE LARGE CABLE RBL F CONN F PIN		ITEM NO DD-XXAFFM-RL7AXX		DRAWN BY Mafei	DATE 2016-09-23	
		SCALE 3:4	SIZE A4	SHEET 2 OF 2	DWG NO DD-XXAFFM-RL7AXX		CHECKED BY Youdan	DATE 2016-09-23	
		REV. C	WC-REV. A.7	 Inspection item	CUSTOMER ALTW		APPROVED BY Jerry	DATE 2016-09-23	
		<h1 style="margin: 0;">Amphenol LTW</h1> <h2 style="margin: 0;">安費諾亮泰企業股份有限公司</h2>						8 FMW10702-01-02A1	