

THIS DOCUMENT IS SUBJECT TO CHANGE WITHOUT NOTICE. IT IS CONFIDENTIAL AND A PROPERTY OF Amphenol LTW. DISCLOSURE TO THIRD PARTY HAS TO BE AUTHORIZED BY Amphenol LTW.

REV.	ECN NO.	DATE	SIGN	DESCRIPTION
A		2020/01/13	Ruru	Initial Released

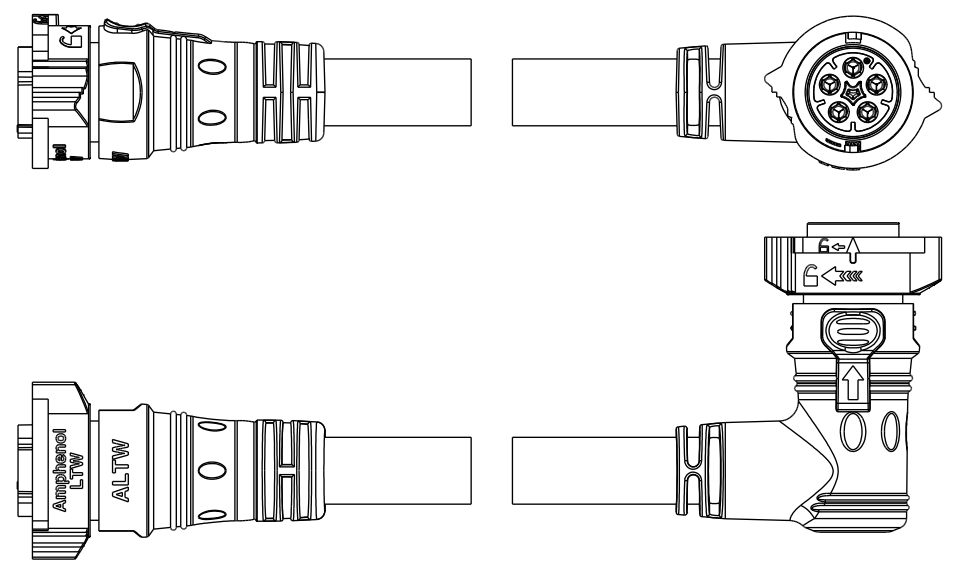
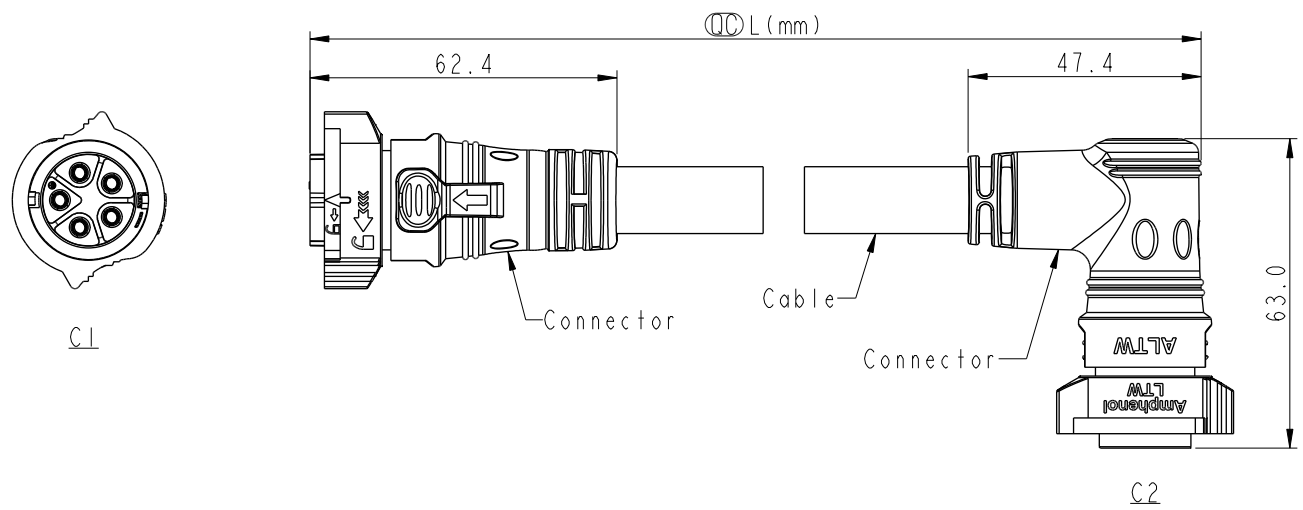

Note:

- * Ⓞ Important Dimension.
- * Waterproof Rate: IP68, Mated.
IP68: 1M depth of water in 24 hours.
- * Connector: Thermoplastic, Black.
- * Pin: Copper Alloy, Gold Plated.
- * Cable: SJTW, PVC Jacket, Black.
- * Cable Length Tolerance:
 - 0.5M: +60/-0mm
 - 01M: +60/-0mm
 - 02~03M: +120/-0mm
 - 04~05M: +160/-0mm
 - 06~10M: ± 100 mm
 - 11~20M: ± 200 mm
 - 21~30M: ± 300 mm
 - 31~99M: ± 500 mm

UNIT: mm		
TOLERANCE	± 0.5 mm	







TITLE ACC, XLOK, D-20A, DB-ENDED FF		
SCALE 1:2	SIZE A4	SHEET 1 OF 2
REV. A	WC-REV.	Ⓞ : Inspection item

Amphenol LTW
安費諾亮泰企業股份有限公司

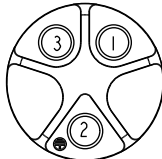

ITEM NO.	DRAWN BY Ruru	DATE 2020-01-13
DWG NO. AB-DCXXFL-DCBR-QEXXX	CHECKED BY Rita	DATE 2020-01-13
CUSTOMER ALTW	APPROVED BY Max	DATE 2020-01-13

5P	PVC	13.6	12	AB-DC05FL-DCBR-QEXXX
3P		11.7		AB-DC03FL-DCBR-QEXXX
2P		10.7		AB-DC02FL-DCBR-QEXXX
Contacts	Cable Jacket	Cable OD	AWG	Item No.

THIS DOCUMENT IS SUBJECT TO CHANGE WITHOUT NOTICE. IT IS CONFIDENTIAL AND A PROPERTY OF AMPHENOL LTW. DISCLOSURE TO THIRD PARTY HAS TO BE AUTHORIZED BY AMPHENOL LTW.

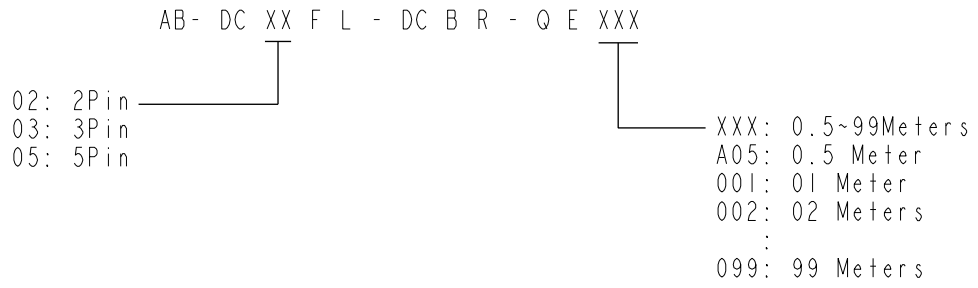
Pin Out	2 White 白 1 Black 黑	3 Green 綠 2 White 白 1 Black 黑	5 Brown 棕 4 Red 紅 3 Green 綠 2 White 白 1 Black 黑
	Pin # Wire	Pin # Wire	Pin # Wire
C2			
	2P	3P	5P
C1			
	2P	3P	5P
Pin Assignments Front View			



UNIT:mm			TITLE ACC, XLOK, D-20A, DB-ENDED FF
TOLERANCE ± 0.5 mm	SCALE 1:2	SIZE A4	SHEET 2 OF 2
	REV. A	WC-REV.	QC: Inspection item

Amphenol LTW

安費諾亮泰企業股份有限公司

ITEM NO.	DRAWN BY Ruru	DATE 2020-01-13
DWG NO. AB-DCXXFL-DCBR-QEXXX	CHECKED BY Rita	DATE 2020-01-13
CUSTOMER ALTW	APPROVED BY Max	DATE 2020-01-13