

THIS DOCUMENT IS SUBJECT TO CHANGE WITHOUT NOTICE. IT IS CONFIDENTIAL AND A PROPERTY OF Amphenol LTW. DISCLOSURE TO THIRD PARTY HAS TO BE AUTHORIZED BY Amphenol LTW.

REV.	ECN NO.	DATE	SIGN	DESCRIPTION
D	C191385	2019/08/02	Siou	Revise Rated Voltage.
E	E191814	2019/10/24	Ruru	△E x 3
F	C210786	2021/06/06	Angel Chou	△F x 5

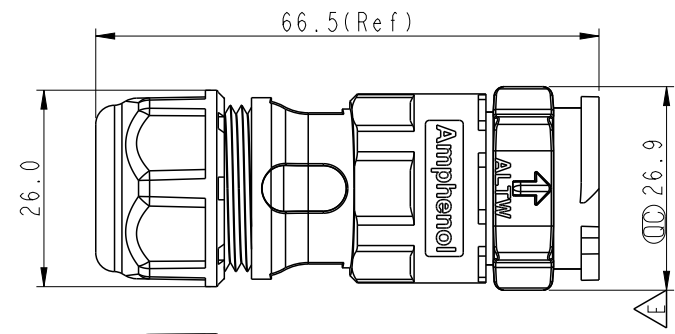
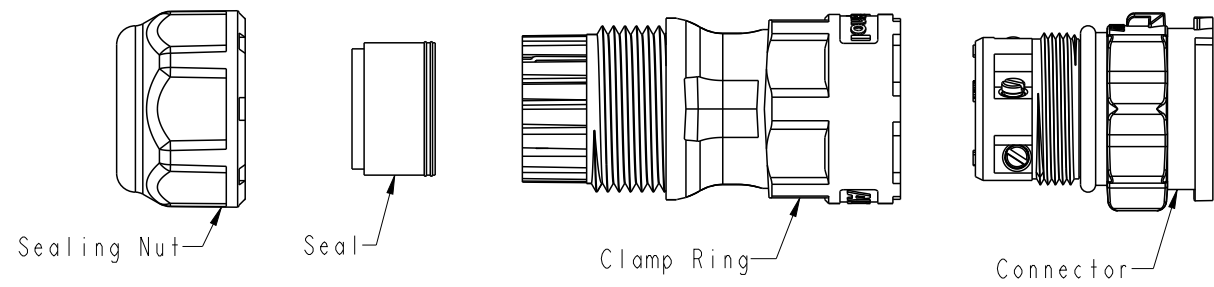

DC-XXBMMB-QL8XPP

△ 02-2 Pin
 03-3 Pin
 △ 04-4 Pin
 05-5 Pin

S: With Red Color Seal 1, Cable OD 8.0~10.0mm.
 M: With Yellow Color Seal 2, Cable OD 10.0~12.0mm.
 L: With Blue Color Seal 3, Cable OD 12.0~14.0mm.
 A: With Seal 1 & Seal 2 & Seal 3.

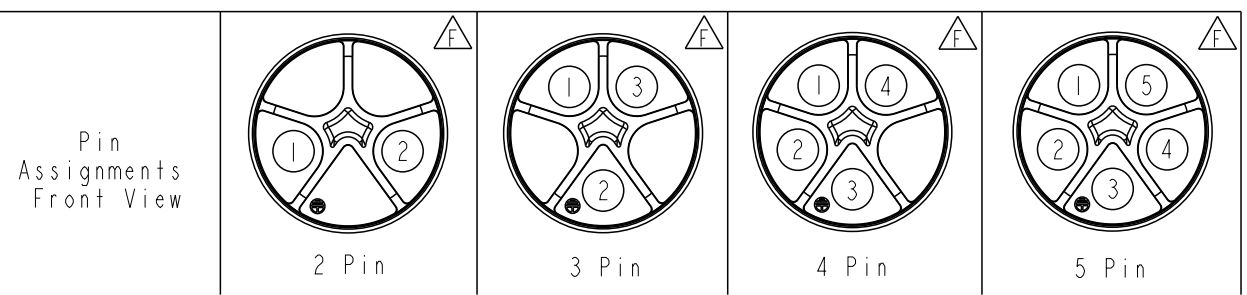
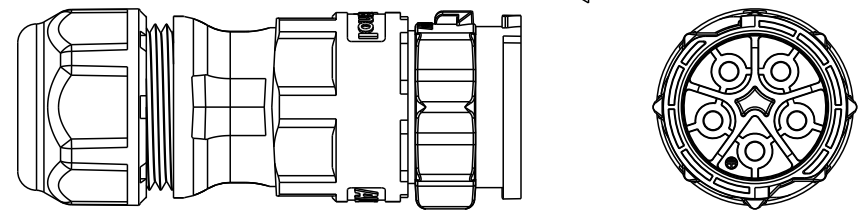

△E △F Note:

- * RoHS Compliant
- * Ⓞ Important Dimension
- * Waterproof Rate: IPX8, Mated 1m/24h
- * Connector Housing: Thermoplastic, Black
- Pin: Copper Alloy, Gold Plated
- Clamp Ring: Thermoplastic, Black
- Sealing Nut: Thermoplastic, Black
- Seals: Rubber

UNIT:mm		TITLE
TOLERANCE	± 0.5 mm	XLOK, D-20A, 03P, CABLE W/O SR M, M, FI SCREW IN, XLOK △E
SCALE	8:5	SIZE A4
REV.	F	WC-REV. A.3
		Ⓞ: Inspection item

Amphenol LTW
安費諾亮泰企業股份有限公司

ITEM NO	DWG NO	CUSTOMER	DRAWN BY	CHECKED BY	APPROVED BY	DATE
	DC-XXBMMB-QL8XPP	ALTW	Siou	Eagle	Neo	2019-08-02

THIS DOCUMENT IS SUBJECT TO CHANGE WITHOUT NOTICE. IT IS CONFIDENTIAL AND A PROPERTY OF Amphenol LTW. DISCLOSURE TO THIRD PARTY HAS TO BE AUTHORIZED BY Amphenol LTW.

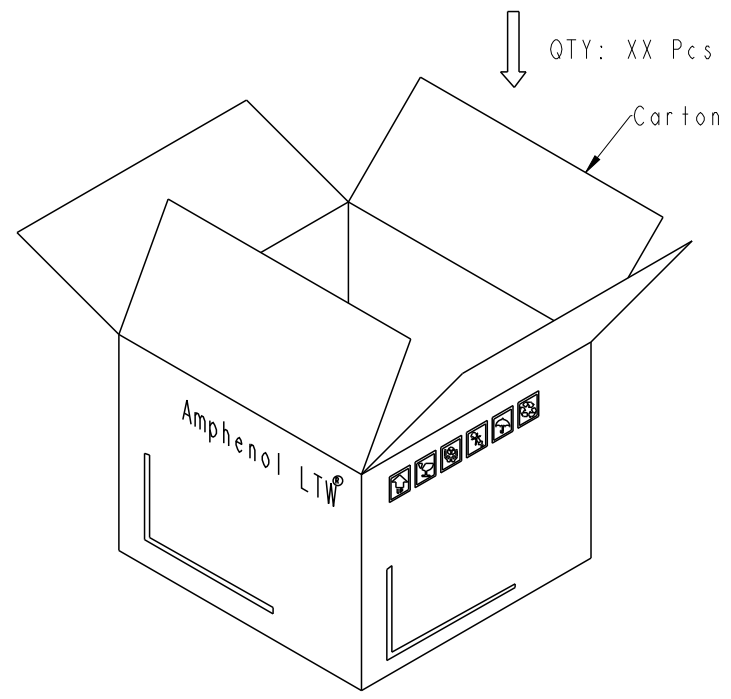
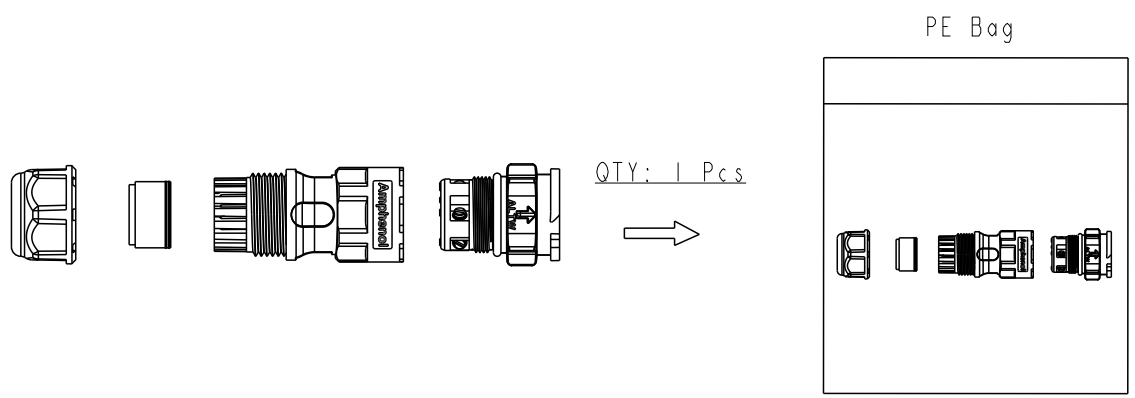

Note:
 * One Set Unassembled In One PE Bag.
 (每一組未組裝，放置於一個PE袋，並封口，如圖示)
 △ * Label is Attached To PE Bag Front.
 (標籤貼在PE袋正面)

UNIT:mm
 TOLERANCE
 ±0.5 mm

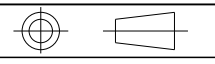

TITLE XLOK, D-20A, 03P, CABLE W/O SR M, M, FI SCREW IN, XLOK			
SCALE 8:5	SIZE A4	SHEET 2 OF 2	
REV. F	WC-REV. A.3	Ⓞ: Inspection item	

Amphenol LTW
 安費諾亮泰企業股份有限公司

ITEM NO	DWG NO DC-XXBMMB-QL8XPP
CUSTOMER ALTW	

DRAWN BY Siou	CHECKED BY Eagle
APPROVED BY Neo	

DATE 2019-08-02	DATE 2019-08-02
DATE 2019-08-02	