

THIS DOCUMENT IS SUBJECT TO CHANGE WITHOUT NOTICE. IT IS CONFIDENTIAL AND A PROPERTY OF Amphenol LTW. DISCLOSURE TO THIRD PARTY HAS TO BE AUTHORIZED BY Amphenol LTW.

REV.	ECN NO.	DATE	SIGN	DESCRIPTION
A	Initial Release	2014/01/24	Aric	New Item.
B	CI90308	2019/03/20	Ruru	Modify Note & Add QC Dimension

**ALTW**  
**CONFIDENTIAL**  
 2019-03-20  
 R&D DEPT.

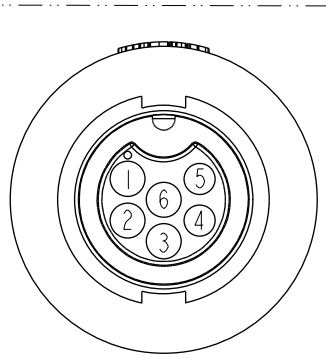
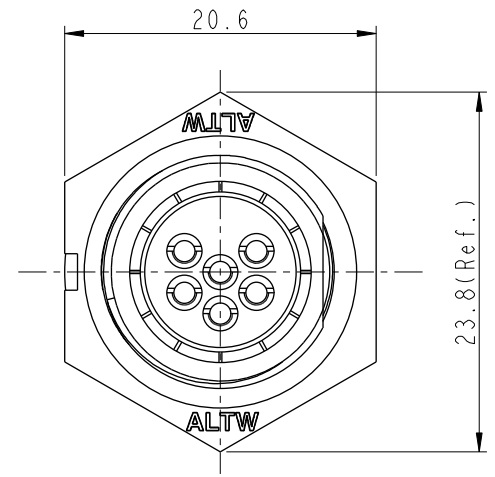
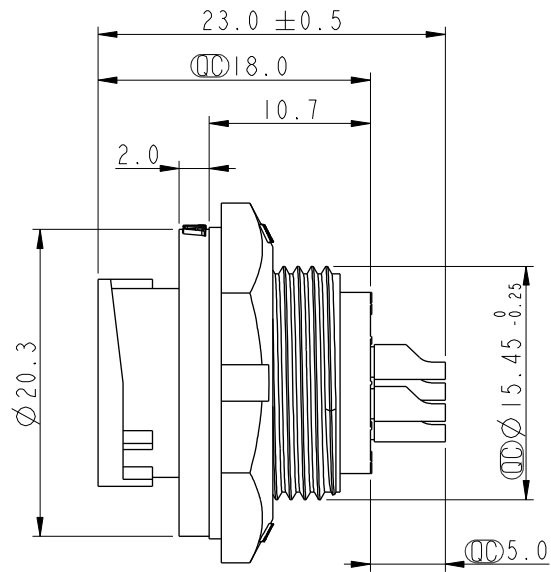
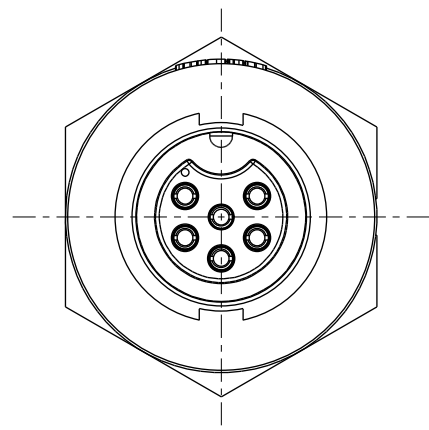

Pin Assignments  
Front View

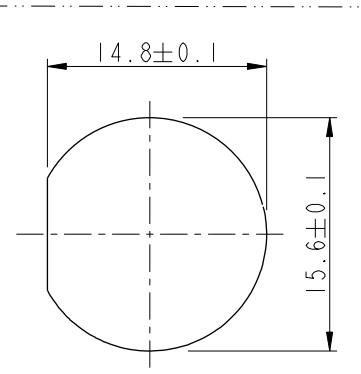

Recommended Panel  
Cut-Out

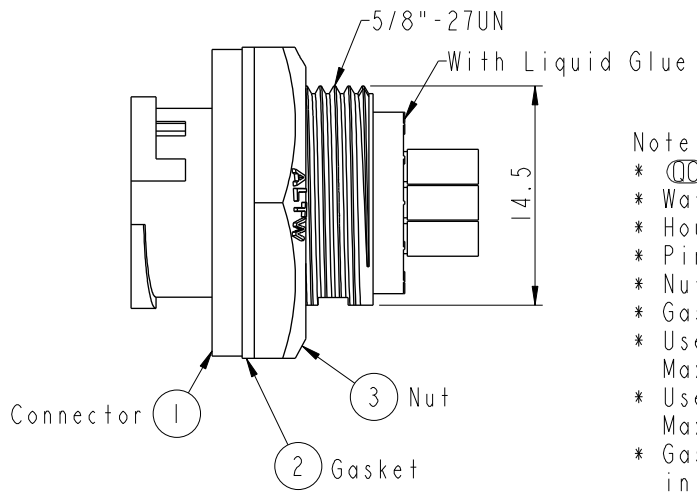

- Note:
- \* Important Dimension
  - \* Waterproof Rate: IP67, Unmated
  - \* Housing: Thermoplastic, Black
  - \* Pin: Copper Alloy, Gold Plated
  - \* Nut: Thermoplastic, Black
  - \* Gasket: Rubber, Gray
  - \* Use with waterproof cap or dust cap  
Maximum Panel Thickness: 2.3mm
  - \* Use without waterproof cap or dust cap  
Maximum Panel Thickness: 3.5mm
  - \* Gasket and Nut are packed separately in PE bags

UNIT: mm	
TOLERANCE	
.X	±0.25
.XX	±0.1
.XXX	±0.05
ANGLES	±1°

TITLE STANDARD CNC PIN PANEL LOCK 6PIN M CONN F PIN			
SCALE 2:1	SIZE A4	SHEET 1 OF 1	
REV. B	WC-REV. A.2	Inspection item	

**Amphenol LTW**  
 安費諾亮泰企業股份有限公司

ITEM NO IBD-06RMFS-LC7001	DRAWN BY Ruru	DATE 2019-03-20
DWG NO IBD-06RMFS-LC7001	CHECKED BY Rita	DATE 2019-03-20
CUSTOMER ALTW	APPROVED BY Max	DATE 2019-03-20