

ALTW
 CONFIDENTIAL
 2019-03-06
 R&D DEPT.

REV.	ECN NO.	DATE	SIGN	DESCRIPTION
B	C190269	2019/03/06	Ruru	Modify Note

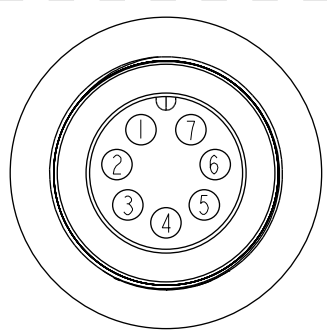

Pin Assignments
 Front View

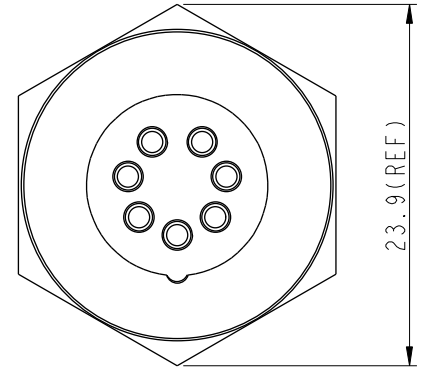
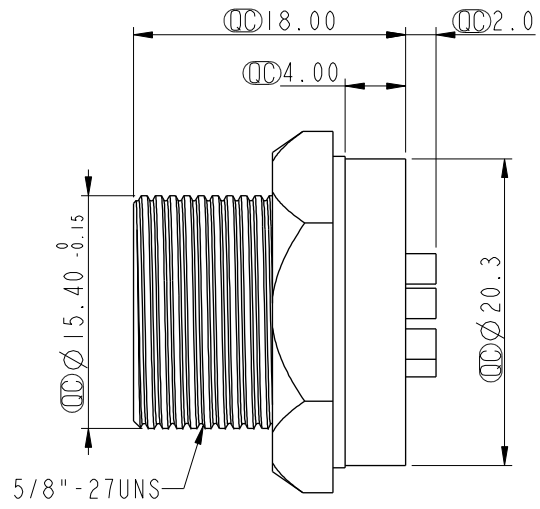
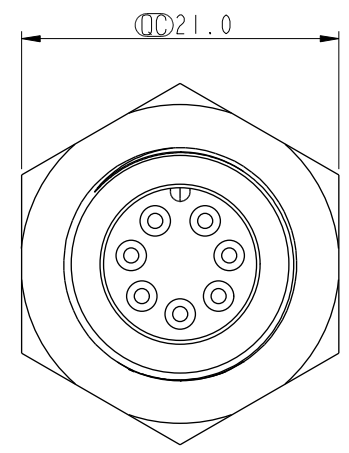
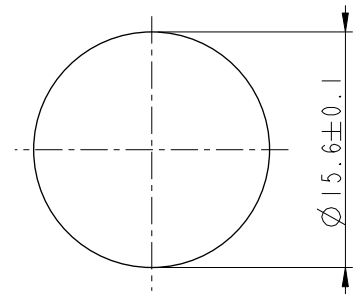

Recommended Panel Cut-out

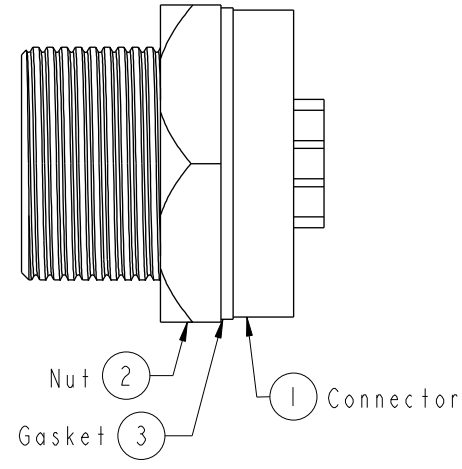

Note: B

- * Important Dimension To Check.
- * Waterproof Rate: IP67, Unmated
- * Housing: Metal, Nickel Plated
- * Pin: Copper Alloy, Gold Plated
- * Nut: Metal, Nickel Plated
- * Gasket: Rubber, Black
- * Maximum Panel Thickness: 4.4mm
- * Gasket and Nut are packed separately in PE bags.

UNIT:mm	
TOLERANCE	
.X	±0.25
.XX	±0.1
.XXX	±0.05
ANGLES	±1°

TITLE Standard Panel Screw 7Pin M Conn M Pin			
SCALE 2:1	SIZE A4	SHEET 1 OF 1	
REV. B	WC-REV. A.2	: Inspection item	

Amphenol LTW
 安費諾亮泰企業股份有限公司

ITEM NO. BSD-07PMMS-SC7001	DRAWN BY Ruru	DATE 2019-03-06
DWG NO. BSD-07PMMS-SC7001	CHECKED BY Rita	DATE 2019-03-06
CUSTOMER ALTW	APPROVED BY Max	DATE 2019-03-06

THIS DOCUMENT IS SUBJECT TO CHANGE WITHOUT NOTICE. IT IS CONFIDENTIAL AND A PROPERTY OF Amphenol LTW. DISCLOSURE TO THIRD PARTY HAS TO BE AUTHORIZED BY Amphenol LTW.