

THIS DOCUMENT IS SUBJECT TO CHANGE WITHOUT NOTICE. IT IS CONFIDENTIAL AND A PROPERTY OF Amphenol LTW. DISCLOSURE TO THIRD PARTY HAS TO BE AUTHORIZED BY Amphenol LTW.

REV.	ECN NO.	DATE	SIGN	DESCRIPTION
F	C201481	2020/09/22	Vicky	$\triangle F$ X4
G	C210020	2021/01/07	Vicky	$\triangle G$ X1
H	C210221	2021/03/18	Vicky	$\triangle H$ X4

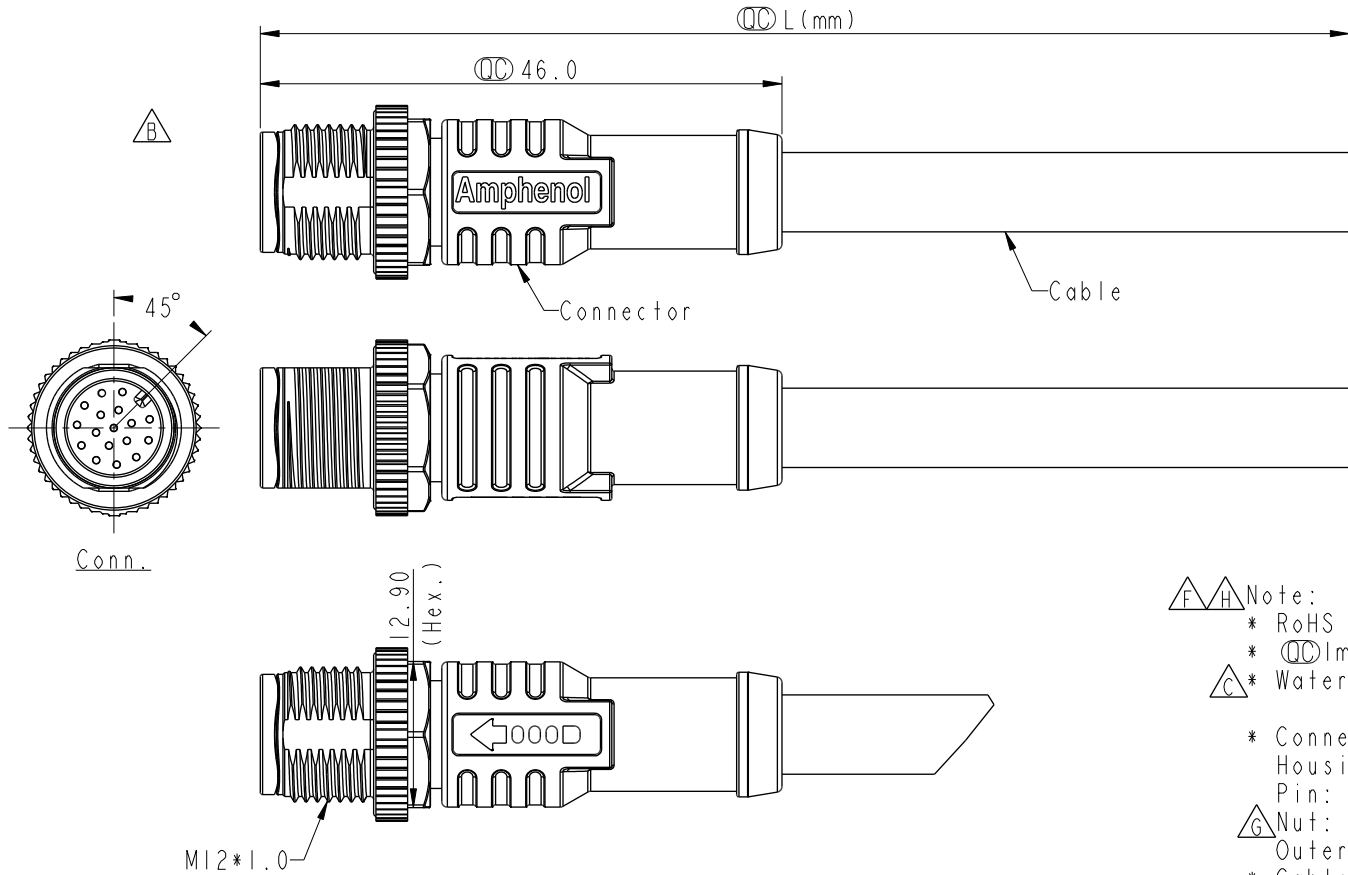

- $\triangle F$   $\triangle H$  Note:
- \* RoHS Compliant
  - \*  $\text{CC}$  Important dimension
  - \*  $\triangle C$  Waterproof rate: IPX8, mated 1m/24h  
IPX9K, mated
  - \* Connector  
Housing: Thermoplastic, Black  
Pin: Copper alloy, Gold plated
  - \*  $\triangle G$  Nut: Metal  
Outer mold: Thermoplastic, Black
  - \* Cable: UL20549, PUR Jacket, Black
  - \* Cable length tolerance: 1M: +50/-0 mm  
1M < L ≤ 3M: +100/-0 mm  
3M < L ≤ 5M: +150/-0 mm  
5M < L ≤ 10M: ±100 mm  
10M < L ≤ 20M: ±200 mm  
20M < L ≤ 30M: ±300 mm  
30M < L ≤ 99M: ±500 mm

UNIT: mm		TITLE	$\triangle H$
TOLERANCE	$\pm 0.5\text{mm}$	N SEN, M12 A, SCREW CABLE W/O SR, M, M, MOLDING	
SCALE	3:2	SIZE	A4
REV.	H	SHEET	1 OF 2
WC-REV.	A.3	$\text{CC}$	Inspection item

**Amphenol LTW**  
安費諾亮泰企業股份有限公司

ITEM NO.	DRAWN BY	DATE
	Lingpeng	2017-04-06
DWG NO.	CHECKED BY	DATE
$\triangle E$ M12A-XXBMMM-SL8BXX	Ma Fei	2017-04-06
CUSTOMER	APPROVED BY	DATE
ALTW	Jerry	2017-04-06

THIS DOCUMENT IS SUBJECT TO CHANGE WITHOUT NOTICE. IT IS CONFIDENTIAL AND A PROPERTY OF Amphenol LTW. DISCLOSURE TO THIRD PARTY HAS TO BE AUTHORIZED BY Amphenol LTW.

 <b>M12A-XXBMMM-SL8BXX</b> XX: No. Of Pin							 17P 12P 10P 8P 6P 5P 4P 3P Contacts	7.0 6.0 4.8 5.0 4.4 4.0 3.8 Cable OD	26 24 22 AWG	M12A-17BMMM-SL8BXX M12A-12BMMM-SL8BXX M12A-10BMMM-SL8BXX M12A-08BMMM-SL8BXX M12A-06BMMM-SL8BXX M12A-05BMMM-SL8BXX M12A-04BMMM-SL8BXX M12A-03BMMM-SL8BXX Item No.
							XX: 01~99Meters 01: 01Meter 02: 02Meters : 99: 99Meters			

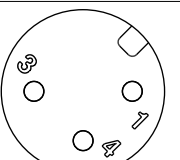
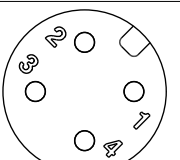
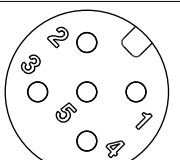
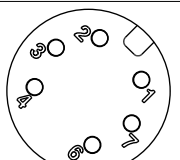
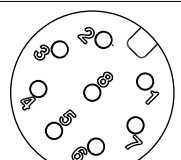
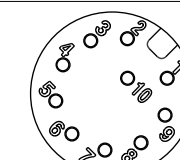
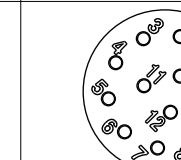
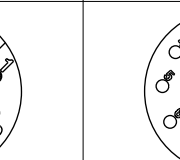
	Pin Out	5 -- 4 Black 黑 3 Blue 藍 2 -- 1 Brown 棕	5 -- 4 Black 黑 3 Blue 藍 2 White 白 1 Brown 棕	5 Gray 灰 4 Black 黑 3 Blue 藍 2 White 白 1 Brown 棕	8 -- 7 Blue 藍 6 Pink 粉 5 -- 4 Yellow 黃 3 Green 綠 2 Brown 棕 1 White 白	8 Red 紅 7 Blue 藍 6 Pink 粉 5 Gray 灰 4 Yellow 黃 3 Green 綠 2 Brown 棕 1 White 白	12 -- 11 -- 10 Violet 紫 9 Black 黑 8 Red 紅 7 Blue 藍 6 Pink 粉 5 Gray 灰 4 Yellow 黃 3 Green 綠 2 Brown 棕 1 White 白	12 Red/Blue 紅/藍 11 Gray/Pink 灰/粉 10 Violet 紫 9 Black 黑 8 Red 紅 7 Blue 藍 6 Pink 粉 5 Gray 灰 4 Yellow 黃 3 Green 綠 2 Brown 棕 1 White 白	17 White/Gray 白/灰 16 Yellow/Brown 黃/棕 15 White/Yellow 白/黃 14 Brown/Green 棕/綠 13 White/Green 白/綠 12 Red/Blue 紅/藍 11 Gray/Pink 灰/粉 10 Violet 紫 9 Red 紅 8 Gray 灰 7 Black 黑 6 Yellow 黃 5 Pink 粉 4 Green 綠 3 White 白 2 Blue 藍 1 Brown 棕
	Conn.								

Pin Assignments Front View

UNIT:mm		TITLE N SEN, M12 A, SCREW CABLE W/O SR, M, M, MOLDING		<b>Amphenol LTW</b> 安費諾亮泰企業股份有限公司	ITEM NO M12A-XXBMMM-SL8BXX	DRAWN BY Lingpeng	DATE 2017-04-06
TOLERANCE ±0.5mm	SCALE 3:2	SIZE A4	SHEET 2 OF 2		DWG NO M12A-XXBMMM-SL8BXX	CHECKED BY Ma Fei	DATE 2017-04-06
	REV. H	WC-REV. A.3	QC: Inspection item		CUSTOMER ALTW	APPROVED BY Jerry	DATE 2017-04-06