

THIS DOCUMENT IS SUBJECT TO CHANGE WITHOUT NOTICE. IT IS CONFIDENTIAL AND A PROPERTY OF Amphenol LTW. DISCLOSURE TO THIRD PARTY HAS TO BE AUTHORIZED BY Amphenol LTW.

REV.	ECN NO.	DATE	SIGN	DESCRIPTION
B	C201807	2020/11/18	Vicky	$\triangle B$ X4
C	C210021	2021/01/07	Vicky	$\triangle C$ X1
D	C210227	2021/03/30	Vicky	$\triangle D$ X4

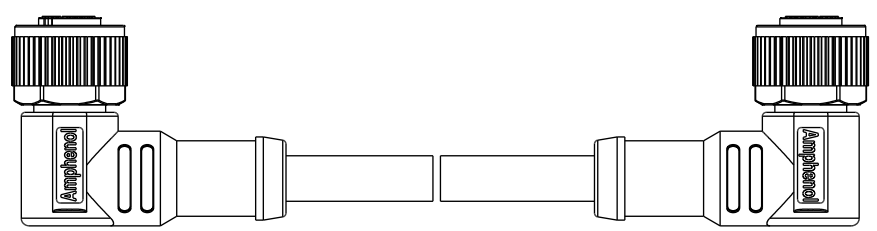
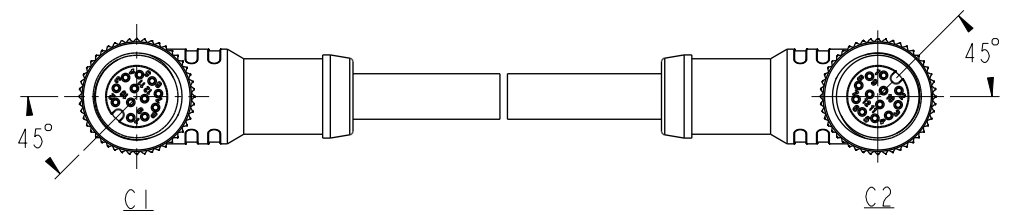
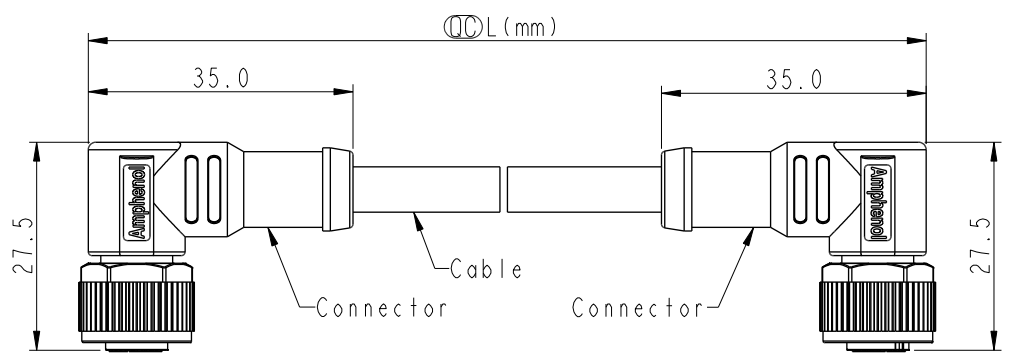

$\triangle B$ $\triangle D$

Note:

- * RoHS Compliant
- * \circledcirc Important dimension
- * Waterproof rate: IPX8, mated 1m/24h
IPX9K, mated
- * Connector
 - Housing: Thermoplastic, Black
 - Pin: Copper alloy, Gold plated
 - O-Ring: Rubber, Green
- $\triangle C$ Nut: Metal
 - Outer Mold: Thermoplastic, Black
- * Cable: UL2517, PVC Jacket, Black
- * Cable Length Tolerance:

0.5M < L \leq 1M	+60/-0 mm
1M < L \leq 3M	+120/-0 mm
3M < L \leq 5M	+160/-0 mm
5M < L \leq 10M	\pm 100 mm
10M < L \leq 20M	\pm 200 mm
20M < L \leq 30M	\pm 300 mm
30M < L \leq 99M	\pm 500 mm

UNIT: mm
TOLERANCE
 ± 0.5 mm

TITLE ACC, SEN, A Code, DB-ENDED $\triangle D$		
SCALE 1:1	SIZE A4	SHEET 1 OF 2
REV. D	WC-REV.	\circledcirc : Inspection item

Amphenol LTW
安費諾亮泰企業股份有限公司

ITEM NO.	DRAWN BY Ruru	DATE 2018-12-05
DWG NO. $\triangle B$ M12AXXFR-12AFR-SDXXX	CHECKED BY Rita	DATE 2018-12-05
CUSTOMER ALTW	APPROVED BY Max	DATE 2018-12-05

THIS DOCUMENT IS SUBJECT TO CHANGE WITHOUT NOTICE. IT IS CONFIDENTIAL AND A PROPERTY OF Amphenol LTW. DISCLOSURE TO THIRD PARTY HAS TO BE AUTHORIZED BY Amphenol LTW.

△B	MI2AXXFR-12AFR-SDXXX						△D	Contacts	Cable OD	AWG	Item No.
								12P	6.0	26	MI2A12FR-12AFR-SDXXX
								10P			MI2A10FR-12AFR-SDXXX
								8P	5.5	24	MI2A08FR-12AFR-SDXXX
								6P	5.0		MI2A06FR-12AFR-SDXXX
								5P	5.1	22	MI2A05FR-12AFR-SDXXX
								4P	4.8		MI2A04FR-12AFR-SDXXX
								3P	4.5		MI2A03FR-12AFR-SDXXX

XX: No. Of Pin

△B

MI2AXXFR-12AFR-SDXXX

XXX: 0.5~99Meters
 A05: 0.5 Meter
 1: 01 Meter
 2: 02 Meters
 :
 99: 99 Meters

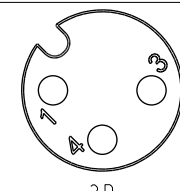
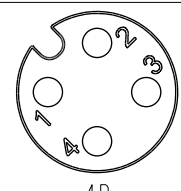
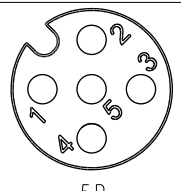
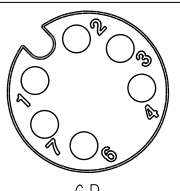
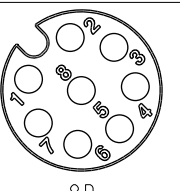
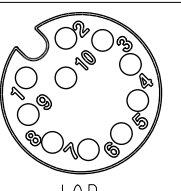
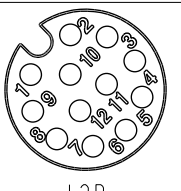
	Pin Out	5 -- 4 Black 黑 3 Blue 藍 2 -- 1 Brown 棕	5 -- 4 Black 黑 3 Blue 藍 2 White 白 1 Brown 棕	5 Gray 灰 4 Black 黑 3 Blue 藍 2 White 白 1 Brown 棕	8 -- 7 Blue 藍 6 Pink 粉 5 -- 4 Yellow 黃 3 Green 綠 2 Brown 棕 1 White 白	8 Red 紅 7 Blue 藍 6 Pink 粉 5 Gray 灰 4 Yellow 黃 3 Green 綠 2 Brown 棕 1 White 白	12 -- 11 -- 10 Violet 紫 9 Black 黑 8 Red 紅 7 Blue 藍 6 Pink 粉 5 Gray 灰 4 Yellow 黃 3 Green 綠 2 Brown 棕 1 White 白	12 Red/Blue 紅/藍 11 Gray/Pink 灰/粉 10 Violet 紫 9 Black 黑 8 Red 紅 7 Blue 藍 6 Pink 粉 5 Gray 灰 4 Yellow 黃 3 Green 綠 2 Brown 棕 1 White 白
		Pin # Wire	Pin # Wire	Pin # Wire	Pin # Wire	Pin # Wire	Pin # Wire	Pin # Wire
CI & C2								
		3P	4P	5P	6P	8P	10P	12P

Pin Assignments Front View

UNIT:mm		TITLE ACC, SEN, A Code, DB-ENDED FF	Amphenol LTW	ITEM NO	DRAWN BY Ruru	DATE 2018-12-05
TOLERANCE ±0.5mm		SCALE 1:1	安費諾亮泰企業股份有限公司	DWG NO MI2AXXFR-12AFR-SDXXX	CHECKED BY Rita	DATE 2018-12-05
		REV. D		CUSTOMER ALTW	APPROVED BY Max	DATE 2018-12-05
		SIZE A4				
		SHEET 2 OF 2				
		WC-REV.				
		◎◎: Inspection item				