

THIS DOCUMENT IS SUBJECT TO CHANGE WITHOUT NOTICE. IT IS CONFIDENTIAL AND A PROPERTY OF AMPHENOL LTW. DISCLOSURE TO THIRD PARTY HAS TO BE AUTHORIZED BY AMPHENOL LTW.

REV.	ECN NO.	DATE	SIGN	DESCRIPTION
E	BOMR19100207	2019/10/30	Peng	Add 17Pin
F	C201604	2020/10/22	Ruru	$\triangle F$ X8
G	C210239	2021/04/13	Ruru	$\triangle G$ X4

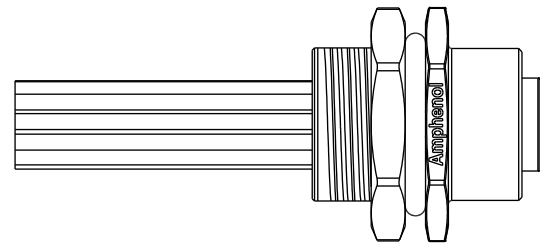

- Note: $\triangle C \triangle D \triangle E \triangle F \triangle G$
- * RoHS Compliant
 - * CC Important dimension
 - * Waterproof rate: IPX8, unmated 1m/24h
IPX9K, unmated
 - * Connector
Housing: Thermoplastic, Black
Pin: Copper alloy, Gold plated
O-Ring: Rubber, Green
 - * Shield: Metal
 - * Nut: Metal
 - * O-Ring: Rubber, Black
 - * Wire harness: UL1061
 - * For panel thickness max: 4.5mm
 - * O-Ring and nut are assembled on connectors
 - * Wire harness tolerance: 100mm: ± 10 mm
100mm < L \leq 300mm: ± 15 mm
300mm < L \leq 1000mm: ± 20 mm
1000mm < L \leq 1500mm: ± 50 mm

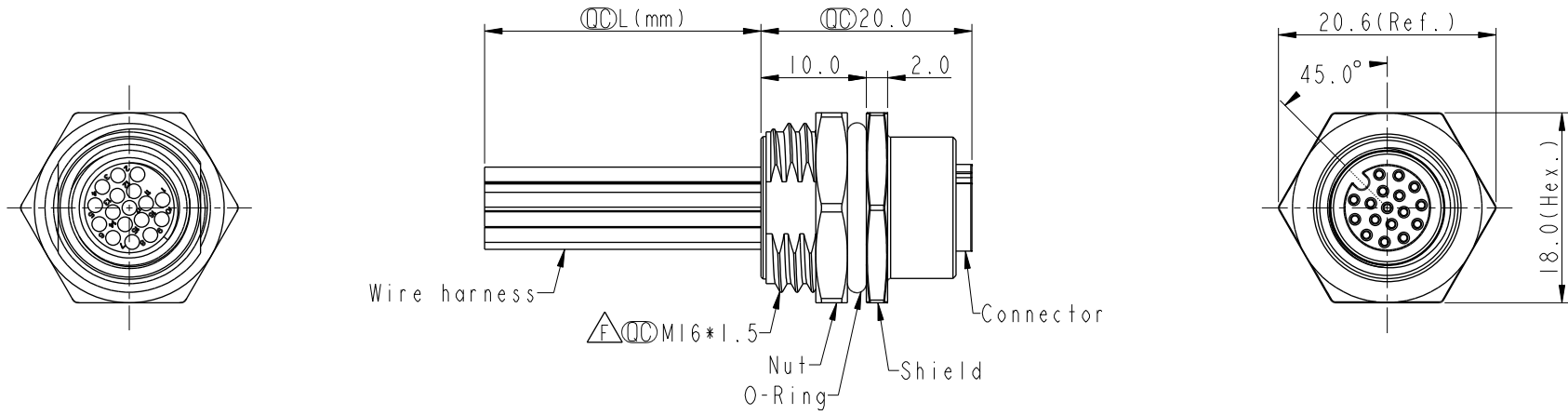
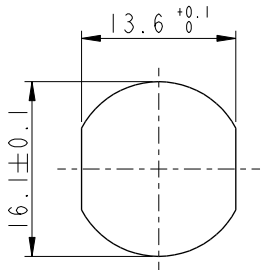

Recommended Panel Cut-Out

UNIT: mm	
TOLERANCE	
.X	± 0.25
.XX	± 0.1
.XXX	± 0.05
ANGLES	$\pm 1^\circ$

TITLE N SEN, M12 A, SCREW RECEPTACLE, F, F, FI/PANEL CRIMP $\triangle G$			
SCALE 3:2	SIZE A4	SHEET 1 OF 2	
REV. G	WC-REV. A.3	CC : Inspection item	

Amphenol LTW
安費諾亮泰企業股份有限公司

ITEM NO.	DRAWN BY Ruru	DATE 2019-09-19
DWG NO. $\triangle E$ M12A-XXPFFC-SH8CXX	CHECKED BY Rita	DATE 2019-09-19
CUSTOMER ALTW	APPROVED BY Max	DATE 2019-09-19

THIS DOCUMENT IS SUBJECT TO CHANGE WITHOUT NOTICE. IT IS CONFIDENTIAL AND A PROPERTY OF Amphenol LTW. DISCLOSURE TO THIRD PARTY HAS TO BE AUTHORIZED BY Amphenol LTW.

	7	8
17P	26	MI2A-17PFFC-SH8CXX
5P	22	MI2A-05PFFC-SH8CXX
4P		MI2A-04PFFC-SH8CXX
3P		MI2A-03PFFC-SH8CXX
Contacts	AWG	Item No.

 MI2A-XXPFFC-SH8CXX

XX: No. Of Pin

- 10: 100mm
- 15: 150mm
- 20: 200mm
- 95: 950mm
- Cable Pitch Unit=50mm
- A0: 1000mm
- A5: 1500mm
- Cable Pitch Unit=100mm
- Wire Length (L): 150-1500 mm



17	White/Gray	白/灰
16	Yellow/Brown	黃/棕
15	White/Yellow	白/黃
14	Brown/Green	棕/綠
13	White/Green	白/綠
12	Red/Blue	紅/藍
11	Gray/Pink	灰/粉
10	Violet	紫
9	Red	紅
8	Gray	灰
7	Black	黑
6	Yellow	黃
5	Pink	粉
4	Green	綠
3	White	白
2	Blue	藍
1	Brown	棕



5	--	5	--	5	Gray	灰
4	Black	4	Black	4	Black	黑
3	Blue	3	Blue	3	Blue	藍
2	--	2	White	2	White	白
1	Brown	1	Brown	1	Brown	棕

Pin # Wire Pin # Wire Pin # Wire Pin # Wire

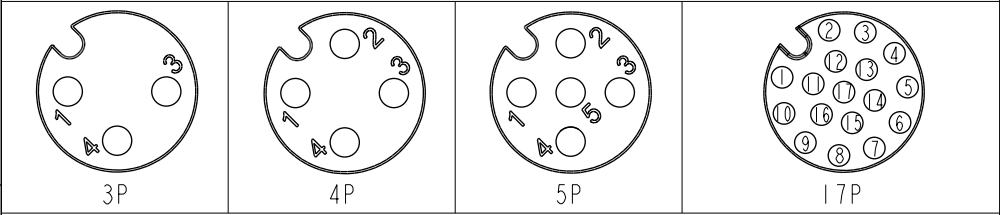
Pin Out



Pin Assignments Front View

UNIT: mm		TITLE N SEN, MI2 A, SCREW RECEPTACLE, F, F, FI/PANEL CRIMP 
TOLERANCE .X ±0.25 .XX ±0.1 .XXX ±0.05 ANGLES ±1°	SCALE 3:2 SIZE A4 SHEET 2 OF 2	REV. G WC-REV. A.3 QC: Inspection item

Amphenol LTW
 安費諾亮泰企業股份有限公司

ITEM NO	DRAWN BY	DATE
	Ruru	2019-09-19
DWG NO	CHECKED BY	DATE
 MI2A-XXPFFC-SH8CXX	Rita	2019-09-19
CUSTOMER	APPROVED BY	DATE
ALTW	Max	2019-09-19