

REV.	DESCRIPTION
B	Change Number
C	Change PIN Number
D	Change Cable dia range

THIS DOCUMENT IS SUBJECT TO CHANGE WITHOUT NOTICE. IT IS CONFIDENTIAL AND A PROPERTY OF AMPHENOL LTW. DISCLOSURE TO THIRD PARTY HAS TO BE AUTHORIZED BY AMPHENOL LTW.

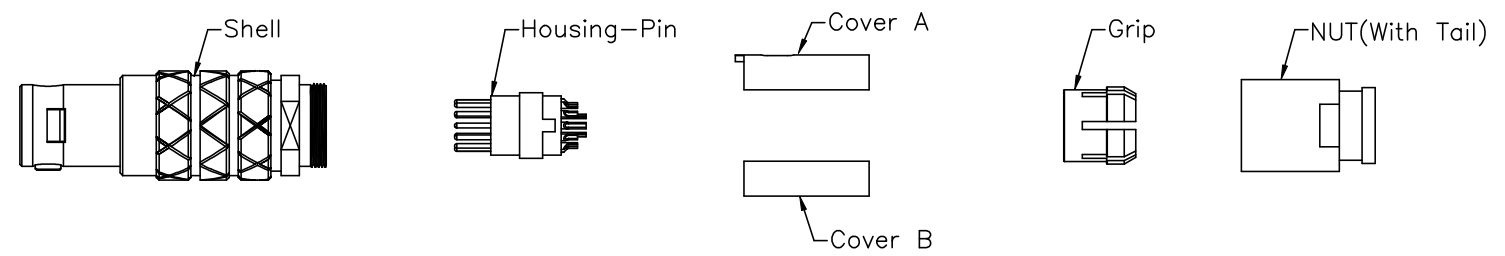

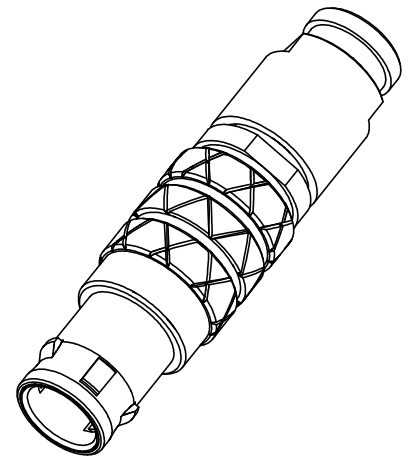

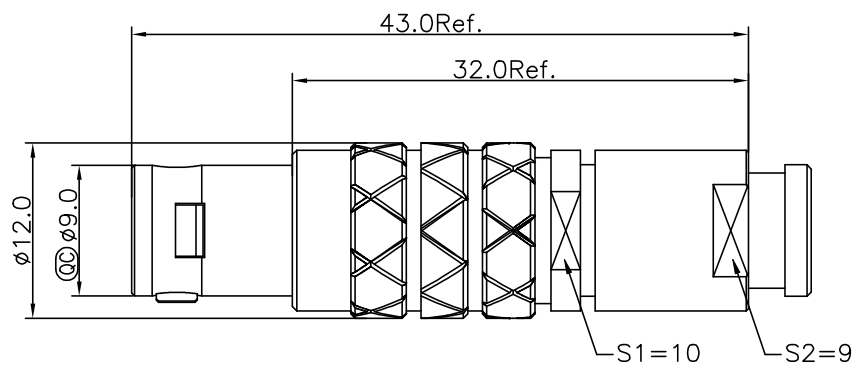







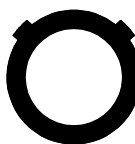

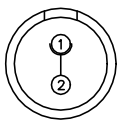
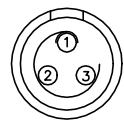
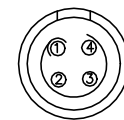
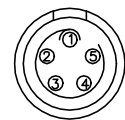
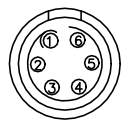
Notes:
 * Ⓞ Important Dimensions To Check.
 * Male Pin: Copper Alloy, Gold Plated.

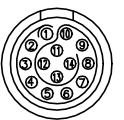

UNIT:mm TOLERANCE ±0.5MM	TITLE FLO 1B FI CONNECTOR		Amphenol LTW 安費諾亮泰企業股份有限公司	ITEM NO	DRAWN BY Ouyang	DATE 2019/09/04
	SCALE Free	SHEET 1 OF 2		DWG NO FLBC-XXFGMS-XCP-XXX	CHECKED BY Mafei	DATE 2019/09/04
	REV. D	SIZE A4		CUSTOMER ALTW	APPROVED BY Jerry	DATE 2019/09/04
		QC : Inspection Item				

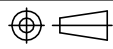
THIS DOCUMENT IS SUBJECT TO CHANGE WITHOUT NOTICE. IT IS CONFIDENTIAL AND A PROPERTY OF Amphenol LTW. DISCLOSURE TO THIRD PARTY HAS TO BE AUTHORIZED BY Amphenol LTW.

1	2	3	4	5	6	7	8			
1B-SERIES CABLE COLLET(CABLE OD)										
CABLE CLAMP SET		CABLE DIA RANGE								
TYPE		CODE ①	MAX	MIN $\triangle D$						
$\triangle B$ FLBC-XXFGMS-XCP-XXX		202	3.2	2.7	$\triangle B$ FLBC-XXFGMS-XCP-XXX					
		204	4.2	3.3						
		207	5.2	4.3						
		211	6.2	5.3						
		214	7.2	6.3						
		--	--	--						
KEY POINT ②										
CODE	G	A	B	C	J	F				
GRAPHIC	0° 	30° 	60° 	90° 	45° 	155° 				
PIN CONFIGURATION (Solder Definition) ③				$\triangle C$						
GRAPHIC	 2 PIN	 3 PIN	 4 PIN	 5 PIN	 6 PIN	 7 PIN	 8 PIN	 10 PIN	 14 PIN	 16 PIN
UNIT:mm		TITLE FLO 1B FI CONNECTOR		Amphenol LTW 安費諾亮泰企業股份有限公司		ITEM NO	DRAWN BY	DATE		
TOLERANCE $\pm 0.5MM$		SCALE Free	SHEET 2 OF 2			DWG NO FLBC-XXFGMS-XCP-XXX	CHECKED BY Mafei	DATE 2019/09/04		
REV. D	SIZE A4	 :Inspection Item				CUSTOMER ALTW	APPROVED BY Jerry	DATE 2019/09/04		
1	2	3	4	5	6	7	8WI0814-03-表單01A2			